

EVIDENCE STORAGE

Secured from **collar to conviction**™



'S
OM
☒

SUPPLIES

REPORT WRITING ROOM

EVIDENCE DEPOSIT
PASS-THRU LOCKERS

EVIDENCE RETRIEVAL
PASS-BACK LOCKERS

REFRIGERATED

RAGE

REFRIGERATED

DRYING
CABINET

EVIDENCE & PROPERTY ROOM

EVIDENCE
DEPOSIT

NON-PASS-THRU
LOCKERS

CURRENCY

EVIDENCE STORAGE
HIGH-DENSITY MOBILE STORAGE SYSTEM

GUNS

NARCOTICS

E

E

BLIC
ANCE

SECURITY. THE STRONGEST LINK.

Evidence – a crucial component needed for taking a case from collar to conviction. The chain of custody must be preserved and the integrity of evidence protected.

Spacesaver® and DSM™ – two trusted names in evidence storage systems – have designed secure storage solutions to meet the needs of any department’s evidence handling processes. We understand there is no “typical” property and evidence room; each having its own process, procedure and personality.

Whether you require lockers for your temporary storage of evidence or need the long-term storage solution of our high-density mobile systems, Spacesaver and DSM have the evidence storage solution for either situation. For narcotics or weapons, bikes or golf clubs, blood or biological samples – Spacesaver and DSM evidence storage systems can store the most unique objects we know you have.



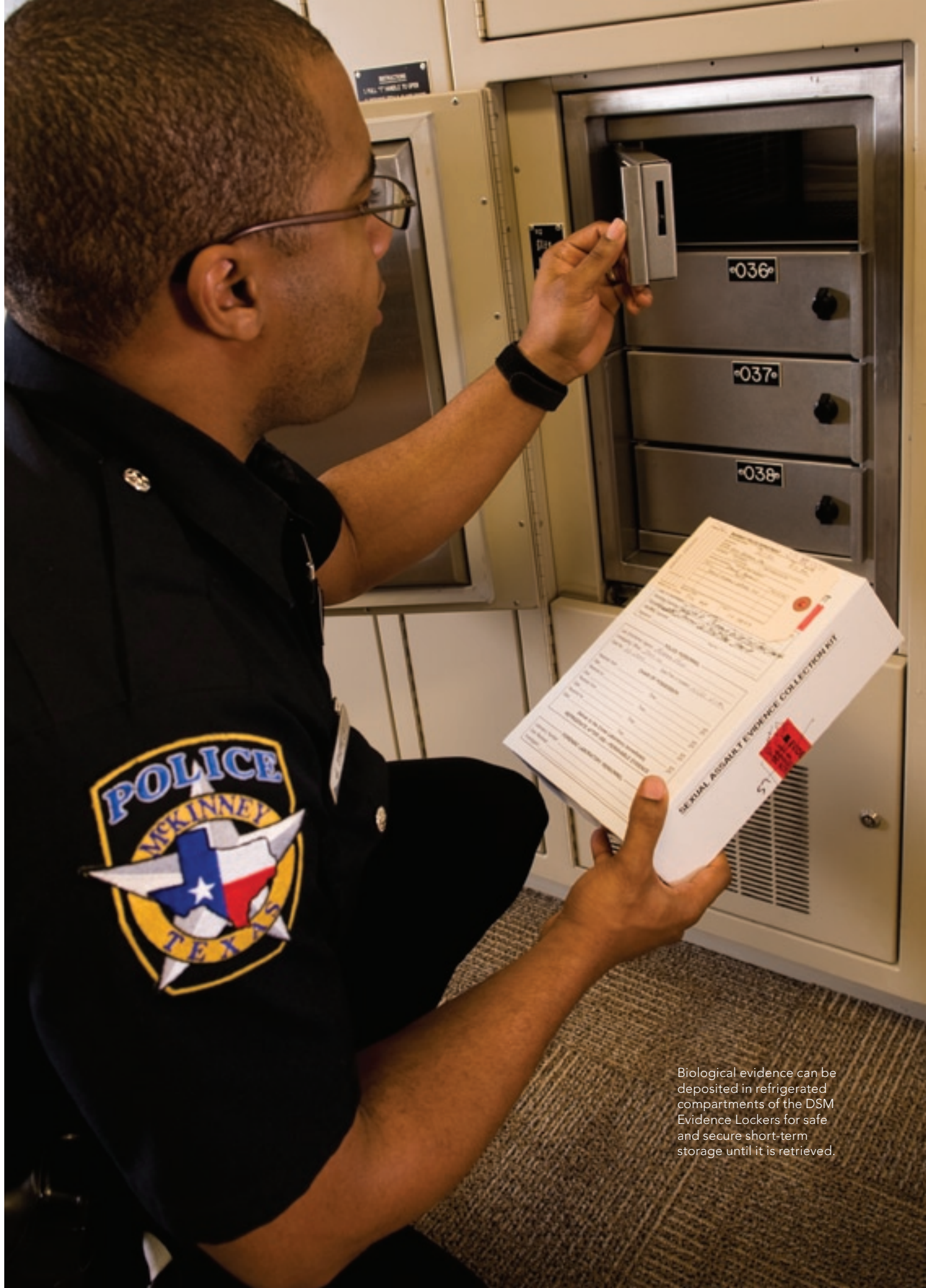

Biological evidence can be deposited in refrigerated compartments of the DSM Evidence Lockers for safe and secure short-term storage until it is retrieved.

Evidence can arrive for processing any time of the day or night. Until it's received by a property room employee, you need a temporary storage solution that can guarantee the security and integrity of evidence. The DSM lockers from Spacesaver provide a secure chain of custody with two distinctive storage processes, both of which do not require keys for deposit of evidence.

INTEGRITY. STANDARD.

PASS-THRU LOCKERS

The pass-thru locker is built into the wall, allowing evidence to be deposited from one side and retrieved from another. The full-size rear door allows the evidence technician to efficiently remove items and reset the locker openings for use.

To further enhance security, we offer an optional front-lock-out system. This feature will automatically lock the front doors when the rear door is opened preventing unauthorized access to the evidence and property room through a locker opening.

NON-PASS-THRU LOCKERS

Unlike the pass-thru locker, evidence is both deposited and retrieved from the same self-closing doors. Items can only be removed by authorized personnel. Our lockers easily mount against a wall and can be converted into a pass-thru configuration at a later date.



The rear door on the DSM pass-thru evidence locker allows for easy removal and reset functions and the convenience of managing a single lock per unit.



Unauthorized access denied.

For ultimate security, the multipoint deadbolt locking system, double-walled, welded doors and anti-pry tabs provide assurance that evidence will not be compromised.

Keyless deposit.

Depositing evidence is simple and efficient with our unique keyless, push-button lock system.



Functional style.

Our nickel-plated recessed handle prevents items and clothing from becoming snagged.



Smooth operation.

The stainless steel, continuous door hinges are self-closing and rest flush with the locker. The tamper-proof pins provide reliable, secure use for years to come.

Ergonomical.

A built-in toe kick assists in alleviating strain when depositing heavy evidence into lockers.





Space that works smarter.

Our standard 82" height offers maximum storage capacity. **Multiple door sizes and configurations** are available for ultimate customization to your required needs.



Attention to detail.

As a finishing touch, **trim kits and concealed fasteners** throughout offer a secure, pleasing appearance.



Built to last.

DSM evidence lockers feature **heavy-gauge, welded construction** for a lifetime of durability. The **high-quality powder coat finish** resists rust and scratches.

Ironclad promise.

Spacesaver stands behind every DSM evidence locker with a **lifetime warranty** on the frame and a **5-year warranty** on moving parts.

ULTIMATE



ACCOUNTABILITY.

FOR A CLEAR, CONFIDENT CHAIN OF CUSTODY.

The DSM A.C.C.E.S.S. 500™ Evidence Management System helps manage daily requests for checking in and out of evidence. Not only will you know **when** evidence has been deposited or retrieved, you'll know **who** handled it as well. The software can even be tied into your video surveillance systems that automatically turn on and record the activity at the locker once the system is activated.

Complete control.

The DSM A.C.C.E.S.S. 500 Evidence Management System boasts features that offer unparalleled preservation of the chain of custody, including:

- Computerized tracking and monitoring of user and locker door activity.
- On-demand activity report generation.
- Automatic door locking when not being accessed
- Multiple levels of security.
- Remote monitoring of multiple locations from a central location.
- Windows-based software and on-site setup and training.



PRESERVING BIOLOGICALS.

REFRIGERATED LOCKERS

Your local appliance distributor doesn't understand the importance of the chain of custody of evidence. So why would you store your critical biological evidence in a standard residential refrigerator with a chain and padlock? Our refrigerated evidence lockers offer the same performance, reliability and security that our standard evidence lockers come with, both with pass-thru and non-pass-thru functionality.

Solid and secure.

- Magnetic seals on front and rear doors.
- Stainless steel double-wall interior.
- Push-button, keyless lock system.
- Variety of lockable compartments.

Keeping a constant cool.

- Refrigerated evidence lockers will maintain a constant 38-to-42 degrees.
- Air circulating fan eliminates hot or cold spots.
- Alarm system to notify authorized personnel of any significant temperature variances.



The full-size refrigerated evidence locker offers 4-24 compartments in various sizes.



The small refrigerator unit is designed to stand alone or fit into any lower 'D' size opening of our evidence lockers. Can be installed on-site into existing DSM evidence lockers as well. Comes standard with four lockable compartments.

EVIDENCE DRYING CABINET SYSTEM

To completely meet all of your temporary evidence storage needs, we offer the DSM Drying Cabinet to safely and securely air-dry blood and biological evidence.

- Connects to existing or new exhaust ducts.
- Secured by a combination lock.
- Louvered door vents with replaceable filter for improved air circulation.
- Magnetic seal prevents odors.

Easy to clean.

- Three racks and one hanger rod that can be removed for cleaning.
- Stainless steel interior components and parts.
- Radius interior corners and a drainage pipe with shut-off valve.



Well known as the leader in High-Density Mobile Storage (HDMS) systems, Spacesaver has the expertise to match specific storage needs ranging from high-profile evidence to general property. Our product solutions provide well-organized, space-efficient storage for today, next year or indefinitely.

OPTIMIZED EFFICIENCY.



Utilizing available space long-term.

Our mobile systems offer secondary levels of security segregated from general evidence whether it's located in a separate room or with Spacesaver's patented locking mechanisms. The storage carriages allow for a variety of storage applications:

- Hanging folders for documentation and general evidence.
- Shelving for boxed evidence.
- Specialized storage units for housing frozen and refrigerated evidence.

These systems can be equipped with touch-pad access for sensitive areas and may be tied into office fire alarm and security systems.

When you add it all together, there really is no comparison. Spacesaver is the industry leader in mobile storage solutions.



To maximize the use of limited space, an Eclipse™ Powered System uses customized shelving to accommodate pistol and rifle boxes. Narcotics are stored beyond the secured access door.

SELECTION WORKSHEET

STANDARD EVIDENCE LOCKERS

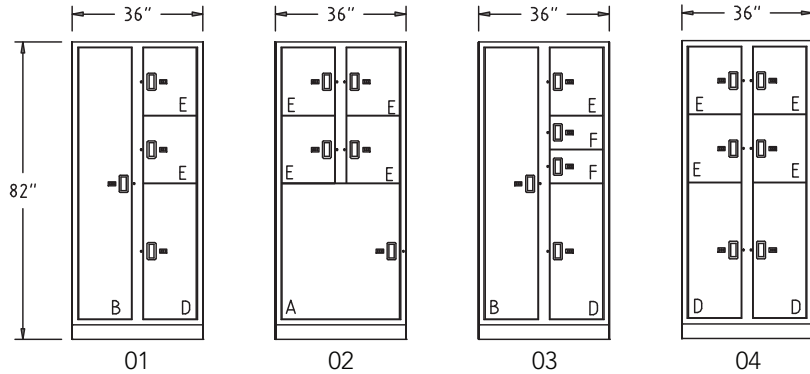

- ALL CONFIGURATIONS AVAILABLE IN NON PASS-THRU (N) AND PASS-THRU (P).
- Small refrigerator can be added to configurations 01, 03, 04, 05 and 18.
- Mail slots can be added to any "E" size doors.
- Available in 33 colors.
- Custom configurations available upon request.

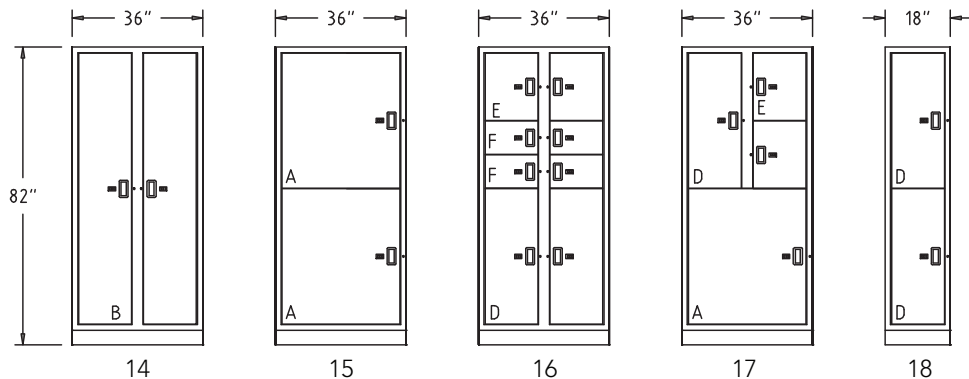
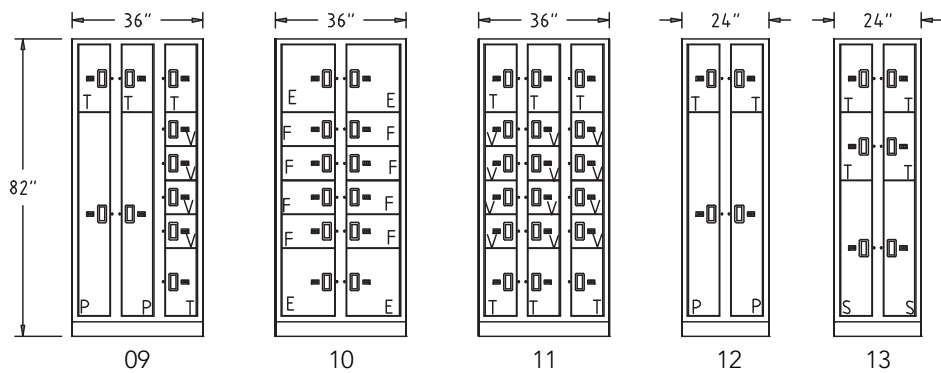
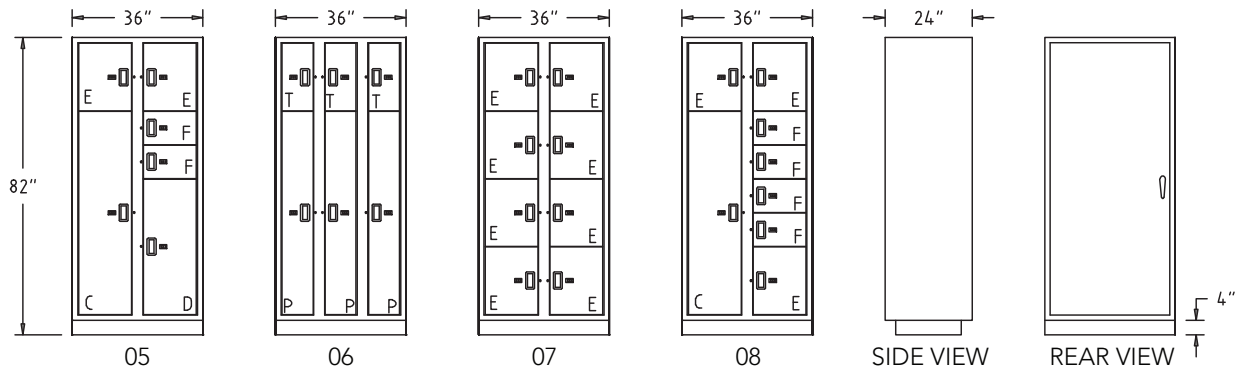

DOOR DIMENSIONS

- A = $32\text{-}\frac{3}{8}$ " W x $37\text{-}\frac{5}{16}$ " H
- B = $14\text{-}\frac{9}{16}$ " W x $74\text{-}\frac{3}{4}$ " H
- C = $14\text{-}\frac{9}{16}$ " W x $56\text{-}\frac{1}{32}$ " H
- D = $14\text{-}\frac{9}{16}$ " W x $37\text{-}\frac{5}{16}$ " H
- E = $14\text{-}\frac{9}{16}$ " W x $18\text{-}\frac{19}{32}$ " H
- F+F = $14\text{-}\frac{9}{16}$ " W x $18\text{-}\frac{19}{32}$ " H
- P = $8\text{-}\frac{9}{16}$ " W x $56\text{-}\frac{1}{32}$ " H
- S = $8\text{-}\frac{9}{16}$ " W x $37\text{-}\frac{5}{16}$ " H
- T = $8\text{-}\frac{9}{16}$ " W x $18\text{-}\frac{19}{32}$ " H
- V+V = $8\text{-}\frac{9}{16}$ " W x $18\text{-}\frac{19}{32}$ " H



A.C.C.E.S.S. 500

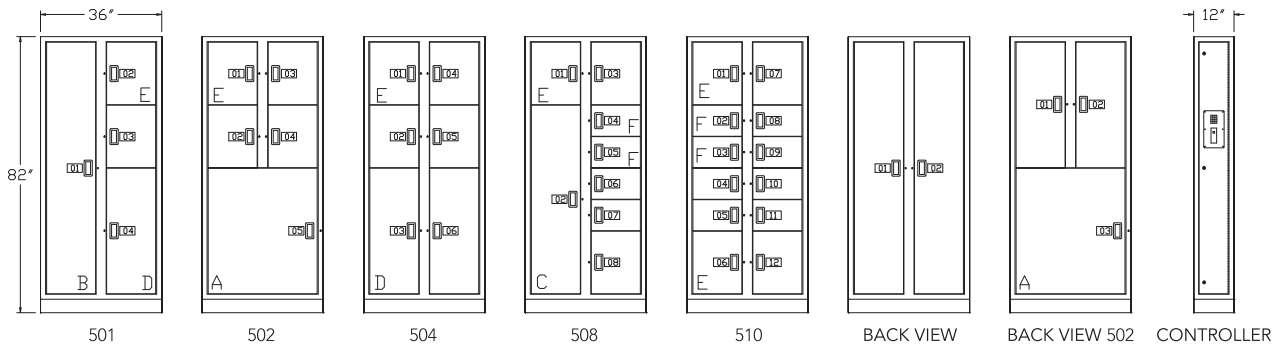

REFRIGERATOR MODEL RS24

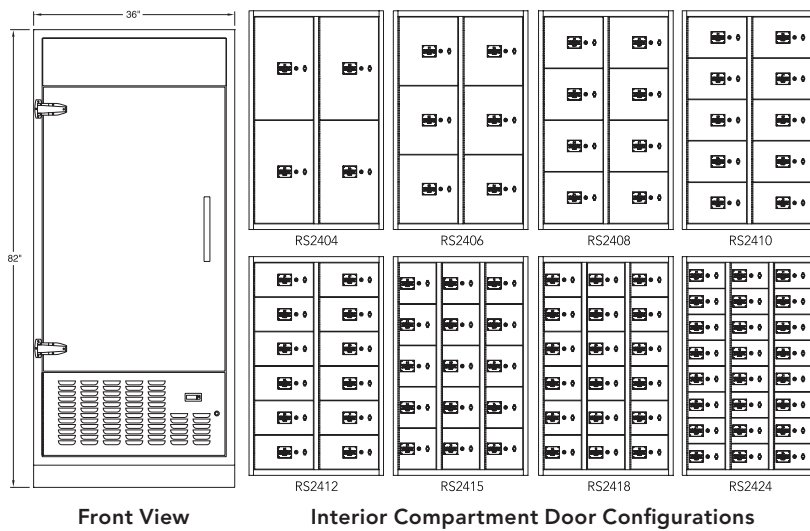

MODEL #	OPENING HEIGHT	WIDTH
EDRS2404PT	22- ³ / ₈ "	11- ³ / ₄ "
EDRS2406PT	14- ⁷ / ₈ "	11- ³ / ₄ "
EDRS2408PT	11- ¹ / ₈ "	11- ³ / ₄ "
EDRS2410PT	8- ⁷ / ₈ "	11- ³ / ₄ "
EDRS2412PT	7- ³ / ₈ "	11- ³ / ₄ "
EDRS2415PT	8- ⁷ / ₈ "	6- ⁷ / ₈ "
EDRS2418PT	7- ³ / ₈ "	6- ⁷ / ₈ "
EDRS2424PT	5- ¹ / ₂ "	6- ⁷ / ₈ "

- Depth: All compartments = 17-¹/₄"
- All dimensions shown indicate maximum size of evidence container that can be put into compartment.
- For non-pass-thru model number, replace PT with NPT

SMALL REFRIGERATOR MODEL RSD4

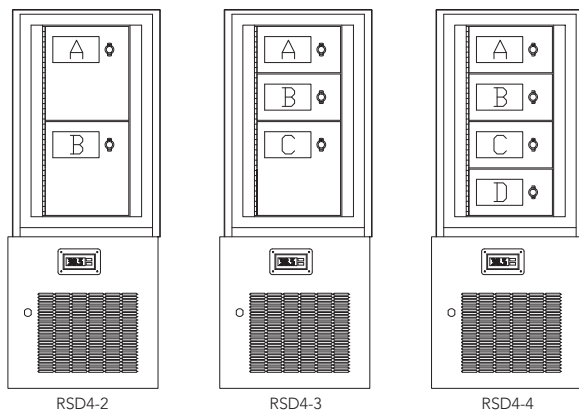

Front Views (shown without main door)

MODEL #	OPENING #	WIDTH	DEPTH	HEIGHT
RSD4-2	1 & 2	7"	15- ¹ / ₂ "	7- ⁷ / ₈ "
RSD4-3	1	7"	15- ¹ / ₂ "	3- ³ / ₈ "
	2	7"	15- ¹ / ₂ "	4- ¹ / ₂ "
	3	7"	15- ¹ / ₂ "	7- ⁷ / ₈ "
RSD4-4	1 & 4	7"	15- ¹ / ₂ "	3- ³ / ₈ "
	2 & 3	7"	15- ¹ / ₂ "	4- ¹ / ₂ "

AVAILABLE OPTIONS



Front Lock-out System
When the rear door is opened access is denied to the front doors, further securing your evidence and property room.

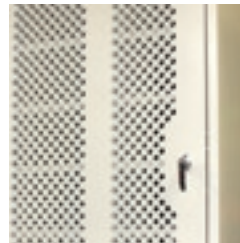

Rear Mesh Doors
Allow visible accounting of evidence. All door components are securely concealed within the double-walled construction.

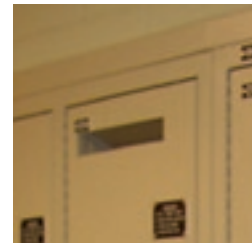

Mail slots
Provides quick deposit of video tapes, CDs and other small packages. Enhances useable space.



Spacesaver Corporation
1450 Janesville Avenue
Fort Atkinson, WI 53538-2798
1-800-492-3434
www.spacesaver.com

Spacesaver Corporation is a division of KI.

KI is a registered trademark of Krueger International, Inc.

Spacesaver is a registered trademark of Spacesaver Corporation.

DSM is a division of Spacesaver Corporation.

© 2008 KI and Spacesaver Corporation. All Rights Reserved. Litho in USA. SC-0808 SSC/MAR 05/08



KI
1330 Bellevue Street
P.O. Box 8100
Green Bay, WI 54302-8100
1-800-424-2432
www.ki.com